

Megaplex-4100/2100/2104

HS-S

4-Channel ISDN "S" Interface Module

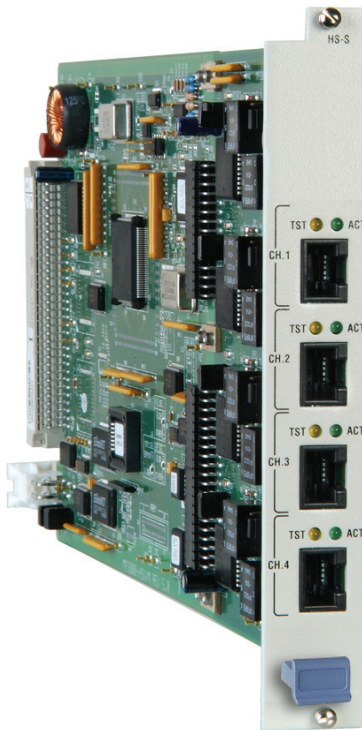

- Four data channels with ISDN "S" interface
- Full duplex transmission of 2B+D channels over 4-wire, at range of up to 1 km (0.6 miles)
- ISDN BRI extender over non-ISDN facilities
- TE or NT operation
- For any I/O slot of Megaplex-2100, Megaplex-2104 or Megaplex-4100

The HS-S data module features four ISDN "S" interface (2B+D) channels. Each channel serves as an ISDN basic rate repeater for transmitting ISDN traffic over non-ISDN media (such as E1/T1 or SDH/SONET networks) via Megaplex-2100/2104 E1/T1 links or Megaplex-4100 E1/T1/SDH/SONET links. Megaplex equipped with HS-S extends ISDN services to locations that do not have ISDN facilities, or where ISDN services are not cost-effective.

Each 2B+D "S" interface channel operates full-duplex over a 4-wire twisted pair at a range of up to 1 km (0.6 miles).

Each B channel can be programmed independently to operate at 2-bit (16 kbps), 4-bit (32 kbps) or 8-bit (64 kbps) rates.

Each D channel can be transmitted transparently using 16 kbps. All four D channels can be placed in a single timeslot (64 kbps). Alternatively, each D channel can be placed in a separate timeslot, to enable splitting "S" interfaces onto different links.

Full transparency of the four "S" interface channels requires nine timeslots. Timeslots used on the E1 or T1 links are individually assigned by the user for each channel.

Each of the four HS-S channels may be directed to any channel of another HS-S module at the remote site. In transparent mode, an HS-S module can also work opposite an HS-U module, enabling communication between 4-wire "S" and 2-wire "U" ISDN facilities (see *Figure 1*).

Operates with the
HS-U module with
ISDN "U" interface



HS-S

4-Channel ISDN "S" Interface Module

All HS-S channels can be user-selected to operate as either TE (terminal equipment) or NT (network termination). In TE mode, the HS-S channels are connected to NT units, such as an ISDN switch (clock used for nodal timing is taken from the connected NT). In NT mode, the user TE is connected directly to the HS-S channels (HS-S channel provides the Megaplex's nodal timing to the connected TE).

HS-S diagnostics include hardware self-tests and both local and remote loopbacks.

HS-S features an optional phantom feeding function, to power the remote user equipment to which it is connected. The source for the phantom feed power can be a -48 VDC chassis power supply, a Ringer-2100R module installed in the chassis, a standalone Ringer-2000 or Ringer-2200N unit connected to the Megaplex AC power supply, or an AC-powered MP-2104 chassis with built-in ringer option. See separate data sheet for information on Ringers.

The operating parameters of HS-S are configurable via a terminal interface, or via the RADview-PC or RADview-HPOV Network Management Systems.

Each channel terminates in a separate 8-pin RJ-45 connector.

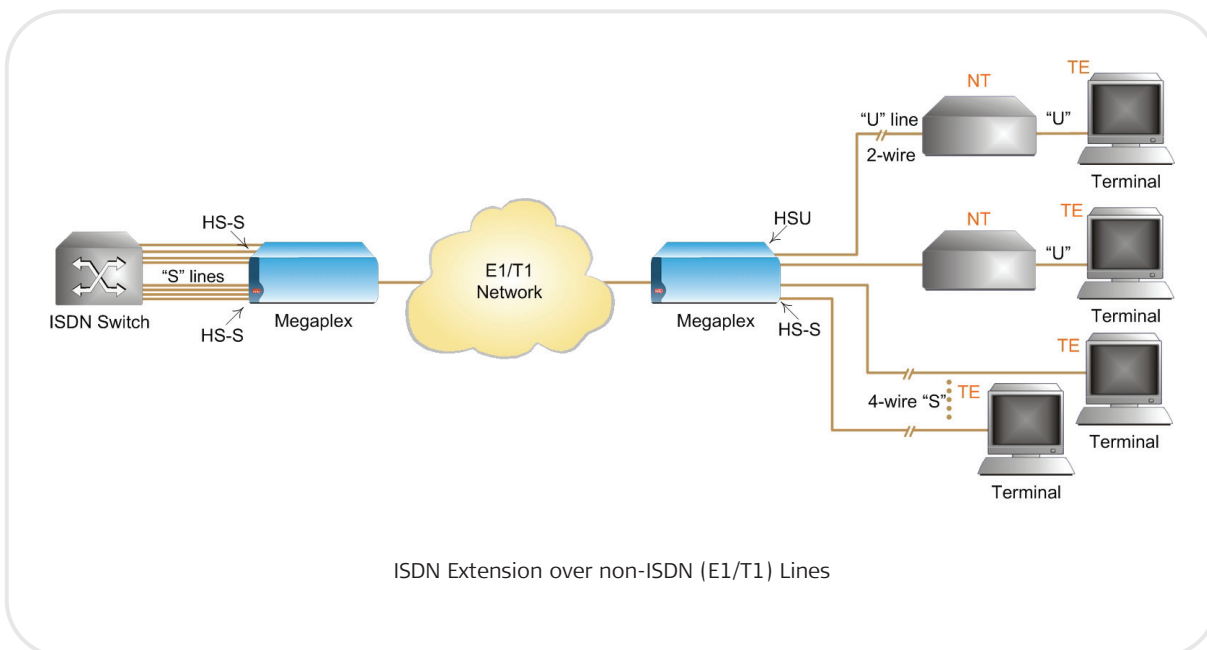

Specifications

"S" INTERFACE

Number of Interfaces

Four "S" (2B+D) channels
2nd line

Compliance

ETSI 300012

Line Code

Pseudo-ternary

Transmission Format

Full duplex

Line Termination

100 Ω , $\pm 5\%$

Range

Up to 1 km (0.6 miles)
over AWG 26 (0.4 mm) wire

Signal Levels

Receive: +1.5 to -7.5 dB relative to
the nominal amplitude
Transmit: ± 750 mV

Connectors

8-pin RJ-45 (one per channel)

TRUNK INTERFACE

Bit Mapping for B Channels

2, 4 or 8 bits (corresponding to data rates
of 16, 32 or 64 kbps, respectively)

Bit Mapping for D Channels

2 bits (corresponding to 16 kbps data
rate)

GENERAL

Timing

TE mode: HS-S is locked to the incoming
clock from the NT (ISDN switch)
NT mode: Transmit timing is locked to the
Megaplex nodal timing

Indicators (per channel)

Active (green): activity detected
Test (yellow): in test mode

Diagnostics (per channel)

Local digital loopback
Remote digital loopback

Configuration

Programmable via terminal interface or
RADview Network Management System

Environment

Operating temperature: 0°C to 45°C
(32°F to 113°F)
Storage temperature: -20°C to +70°C
(-4°F to +160°F)
Humidity: up to 95%, non-condensing

HS-S







4-Channel ISDN "S" Interface Module

Ordering

MP-2100M-HS-S

If power feed is required, refer to the *Ringer data sheet* for information and ordering.

Megaplex High-Speed Modules

	HS-2	HS-Q/N	HS-6N/ HS-12N	HS-U/HS-U-6/ HS-U-12	HS-703	HS-S	HSF-1/HSF-2
Feature							
Interface Type	V.24/RS-232, V.35, X.21 or V.11/RS-422	V.24/RS-232, V.35, X.21 or V.11/RS-422	V.24/RS-232, V.35, X.21 or V.11/RS-422	ISDN "U"	G.703	ISDN "S"	IEEE C37.94 Fiber optic
Number of Channels	2	4	6/12	4/6/12	4	4	1/2
Number of Connectors	2	4	2/4	4	4	4	1/2
Data Rate	n x 64 kbps n x 56 kbps	n x 64 kbps n x 56 kbps	n x 64 kbps	128 kbps	64 kbps	128 kbps	up to 10x64 kbps
Supported by MP-4100	-	-	✓	HS-U-6 HS-U-12	✓	✓	HSF-2

International Headquarters
24 Raoul Wallenberg Street
Tel Aviv 69719, Israel
Tel. 972-3-6458181
Fax 972-3-6498250, 6474436
E-mail market@rad.com

North America Headquarters
900 Corporate Drive
Mahwah, NJ 07430, USA
Tel. 201-5291100
Toll free 1-800-4447234
Fax 201-5295777
E-mail market@radusa.com

www.rad.com

Order this publication by Catalog No. 803780



data communications

The Access Company